

EASTBOURNE TRIATHLON FESTIVAL

10th - 11th JUNE 2023

ATHLETE GUIDE

 **GREAT BRITAIN
AGE GROUP
2024 TEAM QUALIFIER**

Choice
VEHICLE RENTALS

EASTBOURNE
COLLEGE



MACMILLAN
CANCER SUPPORT

Choice
VEHICLE RENTALS

ZONE3

EASTBOURNE
COLLEGE



Welcome to the 2023 Eastbourne Triathlon Festival

We are excited to be welcoming you to the beautiful seaside town of Eastbourne for the 2023 Eastbourne Triathlon Festival on Saturday 10th and Sunday 11th June. For the first time, Eastbourne Triathlon will be a two-day triathlon festival with races taking place on Saturday afternoon and Sunday morning. The event is once again hosting British Triathlon Age-Group Qualifiers for the Standard Distance Triathlon European Championships.

There will be **no face-to-face race briefing on the day**, so you **must read the information provided in this guide carefully**. It covers everything you need to know including certain important points which you must read and understand before the race.

Please note, during the week leading up to the event we will be on site setting up and we will not be able to respond to emails. For any last-minute queries, please visit the help desk at registration.

We are always in need of volunteers both on Saturday and Sunday. If you have friends or family who can help, please email volunteers@tribourne.co.uk.

Following the race, your feedback is always very important for us. We can't wait to hear all about your day and hope you will share your race day experience with us.

We wish you the very best of luck with your remaining days of training and of course on race day.

Mat Dowle and Dale Anderton
TriBourne Multisport Events Ltd.

IMPORTANT

**There will be no race briefing on the day.
It is compulsory to read this briefing
document before the race.**

**Please note this guide is for events taking place on
Sunday 11th June. Separate guides are available for
events taking place on Saturday.**

ENDLESS HORIZONS ENDLESS OPPORTUNITIES



Find out more and enquire online
www.eastbourne-college.co.uk

Schedule

To avoid delays on race morning, we would ask **where possible that if you are racing on Sunday, you should register and collect your race pack on Saturday afternoon between 1:00pm to 5:00pm**. This will allow you to proceed directly to transition for racking on Sunday morning.

Saturday 10th June

12:00pm - Scootathlon Registration opens
1:00pm - General Registration opens
1:00pm - Scootathlon (age 3-8) - Scoot, bike, run
3:10pm - WAVE 1 - RED - TriStart Triathlon (age 8) - Swim 100m, bike 1.5km, run 600m
3:20pm - WAVE 2 - YELLOW - TriStar 1 Triathlon (age 9-10) - Swim 200m, bike 3km, run 1.2km
3:30pm - WAVE 3 - GREEN - TriStar 2 Triathlon (age 11-12) - Swim 300m, bike 6km, run 1.8km
4:00pm - WAVE 4 - BLUE - TriStar 3 Triathlon (age 13-14) - Swim 400m, bike 7.5km, run 2.4km
4:10pm - WAVE 5 - PINK - Youth Triathlon (age 15-16) - Swim 400m, bike 9km, run 2.4km
4:30pm - WAVE 6 - ORANGE CAPS - Super-Sprint Triathlon - Swim 400m, bike 9km, run 2.4km
5:00pm - Registration closes
5:00pm - WAVE 7 - YELLOW CAPS - Team Relays (age 15+) - Swim 300m, bike 6km, run 2.4km x4
8:30pm - Event closes

Sunday 11th June

5:30am - Registration open
6:00am - Transition open
7:45am - Sprint transition closed
7:50am - WAVE 1 - PINK CAPS - Sprint Male/Open Under 50, Male/Open Aquathlon, Relay
8:00am - WAVE 2 - YELLOW CAPS - Sprint Female, Male/Open 50+, Female Aquathlon
8:00am - Registration close
8:20am - WAVE 3 - Sprint and Standard Duathlon
8:20am - Standard transition check-in closed
8:30am - Standard transition closed
8:50am - WAVE 4 - ORANGE CAPS - Standard Male/Open Under 45
8:55am - WAVE 5 - GREEN CAPS - Standard Male/Open 45+, Aquathlon, 1,500m Swim, Relay
9:00am - WAVE 6 - RED CAPS - Standard Female, Female Aquathlon, Female 1,500m Swim
9:45am - Transition open to sprint distance athletes for bike collection
11:30am - Transition open to all athletes for bike collection
1:30pm - Race cut-off time*
2:30pm - Event closes

* The organisers reserve the right to ask any participant to curtail any leg of the event at their discretion to ensure competitor safety and for the route to be re-opened on schedule.

Choice

VEHICLE RENTALS

OFFICIAL TRIBOURNE VEHICLE PARTNER



Choice have been a massive supporter of our events, and we would like to ask you to support them in return. If you need to hire a vehicle please consider using Choice Vehicle Rentals just quote code tribourne to receive your 15% discount.

European Championship Qualifiers

Eastbourne Triathlon is hosting the British Triathlon Age-Group Qualifiers for the Standard Distance Triathlon European Championships. Some of the best age-group athletes in the country will be racing in Eastbourne for a chance to qualify to represent Team GB in the 2024 European championships.

IMPORTANT: Athletes intending to qualify for the GB Age-Group Team **must register their intent to qualify via the BTF website by 5pm on Friday 9th June**. Additional details can be found here: https://www.britishtriathlon.org/gb-teams/age-group/2024-standard-triathlon-european-championships_17225

Spectators

The Eastbourne Triathlon is a great event for spectators, and we would like to encourage you to bring your friends and family to watch you race. The location next to the beach is great for the whole family. This year the event will feature a full event village with a bar, food, ice-cream and various other vendors and stalls.

Location

The event takes place at the **Western Lawns, Eastbourne, BN21 4EH.**



BECOME A HOST FAMILY

Parking

There is no specific parking for the event, but there is plenty of on-street parking on the roads in the area. The map below shows the nearby roads where on-street parking is free of charge (highlighted in yellow). You may need to walk around 1km so plan to arrive early to give yourself time to find a parking space and walk from your car to the race venue at the Western Lawns. **Please note, on Sunday paid parking is available on the main seafront road (King Edward's Parade) however this road forms part of the closed bike route and you will not be allowed to leave until the road reopens at 11:45am. Please only park here if you intend to leave after this time.**



Saturday No Parking Zone

There will be no parking on Saturday afternoon on King Edward's Parade between Wilmington Square and Bolsover Road as shown in red below. **All vehicles must be removed from this area by 3pm.**



Accommodation

There are numerous hotels in Eastbourne, many located close to the race venue. For those travelling from further afield, we highly recommend arriving on the Saturday and staying close to the race venue to avoid unnecessary stress on race morning.

The Lansdowne hotel is situated directly next to the event and are offering participants a 15% discount.

Please use this link to book:

<https://be.synxis.com/?adult=2&chain=5301&hotel=41083&locale=en-G B&adult=2&coupon=IRON15>

The Lansdowne has the following available:

- Storage for bikes
- Menu for participants (Pasta, etc)
- Flexible breakfast times
- Sunday Brunch / lunch

Site Layout

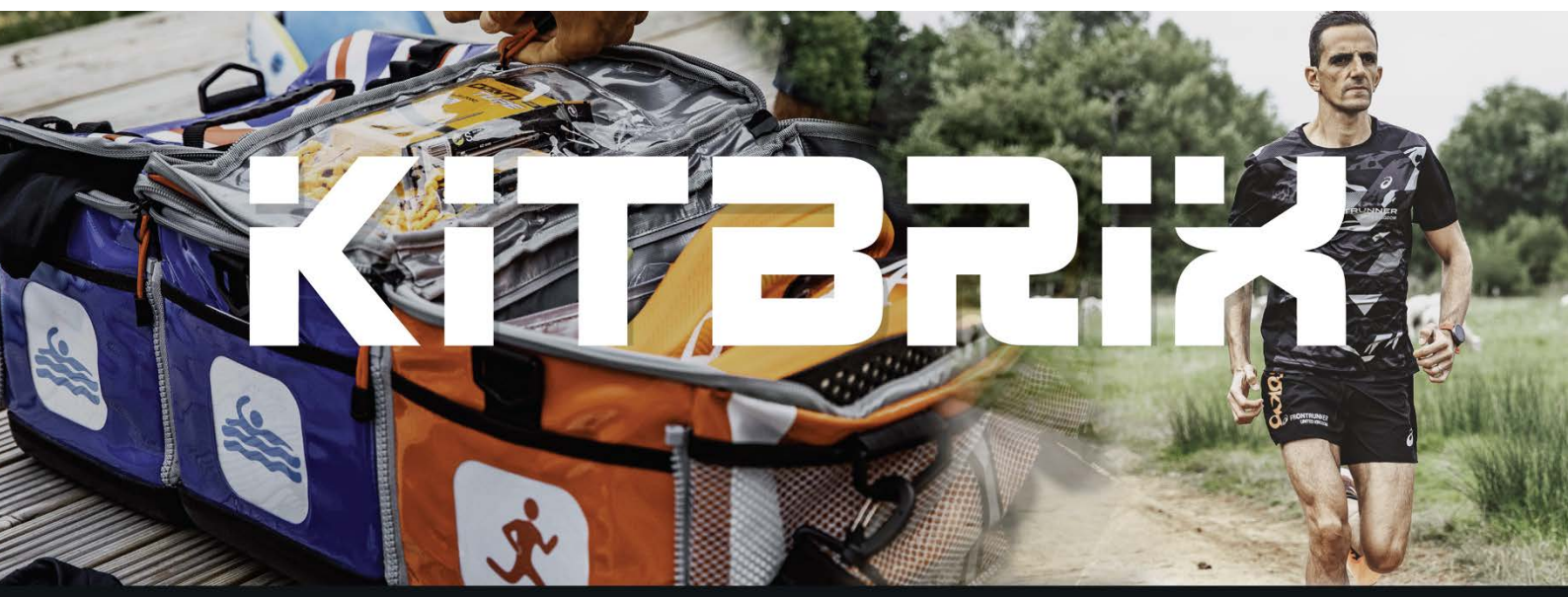

Registration

Registration is situated on the Western Lawns next to the big wheel. Where possible, please register on Saturday afternoon to minimise queuing on race day. Once you arrive at the registration desk, **please give your last name** and we will check your details.

If you are a BTF member you will be asked to show your BTF licence at registration. Since the BTF moved to electronic licences you must sign into your BTF account to access your licence. Please do this before arriving at registration to avoid delays. **We suggest taking a screenshot of the licence on your phone or printing a paper copy so you can access it quickly at registration.**

If you are **not** a BTF member you will have purchased a day-licence when you signed up for the event. You will be emailed a copy of this a few days before the event for your information only, but there is no need to bring this to the event.

Once we have checked your details you will be handed your race pack. Your race pack will contain all the essential items for your race. Please take the time to go through it all carefully.

Your pack will contain a numbered wrist band. **This must be worn throughout the event and must not be removed until after you have collected your bike from transition at the end of the event.** The wrist band has your race number which will be used to identify you in case of a medical emergency and to collect your kit from transition after the race.



Start your training on the right foot with a little help from HIGH5 - our on-course nutrition partner. Use coupon code Tribourne23 to get your exclusive discount on the HIGH5 Cycle Pack to help you be at your best.

Your race pack will also contain the following:

- **Number sticker sheet** - This will include a helmet number sticker (which must be stuck to the front of your helmet before you check your bike into transition) and a long bike number sticker which you must stick around your seat post such that the number is clearly visible from both sides. These stickers should not be taken off until you remove your bike from transition after the race. For security, the bike number and your wrist band must match for you to remove your bike from transition after the event.
- **Two race numbers** - Your race number must be on your back during the cycle and on the front during the run. You can either use a single number attached to an elastic number belt or you can fix one number on your front and the other to your back. Most people will use a race belt but if you wish to you can pin on your numbers. Remember, you **must wear your race number on your back during the bike and on your front during the run**, so don't forget to spin your race belt around in T2 if you choose to use one.
- **Your timing chip** - As you pass various timing points on the course, this will record your times for each leg of the race. You must wear your timing chip around your **left ankle**. We advise you to make sure it is attached securely. Please be aware that no timing chip, or incorrect use of the chip will mean you will not appear in the results. If you have any timing queries after race day, please email us. The timing chip is your responsibility until you hand it back at the finish. Due to the costs of the timing technology, there will be a £40 charge if you fail to return your timing chip. **If you register on Saturday, don't forget your timing chip on Sunday morning.**
- **Swim cap** - During the swim, you must wear the swim cap provided. The colour of the swim cap will identify your starting wave.

Bike Check-in and Pre-Race

Bike check-in will take place on Sunday morning only. If you register on Saturday, you can proceed directly to bike check-in on Sunday morning. Please ensure your bike sticker is on your bike and your helmet is on your head and fastened before arriving at transition check-in. You will enter transition via the bike-check gate situated next to the TriBourne Star Tent. As you enter transition, sprint distance competitors should bear right into the sprint transition area and standard distance competitors continue along to the left.

Transition is a secure area, and you will only be allowed to enter if:

- You are wearing your numbered **wrist band**.
- **Your helmet is fastened** on your head before you pass through the bike check-in. This must be an approved cycling helmet of ANSI Z90.4, SNELLB90, EN 1078 or an equivalent national standard. (NOTE: a CE mark is NOT an approval mark). NB: any helmet bought in recent years will comply but check for damage which would stop it protecting you properly.

- **Your Bike is safe.** It is your responsibility to bring a bike that is road worthy and complies with the BTF rules (visit www.britishtriathlon.org for more information). Your handlebars must not have open metal ends so please obtain bar ends to plug them before coming to the race. Fixed wheel bikes (bikes that use the pedals as a brake) are not permitted in the race and e-bikes are also not permitted.

You must not use headphones, mobile phones or any other such devices in transition which could be considered a distraction.

Racking is numbered with odd numbers on one side and even numbers on the other. For fairness, age-groups will be grouped together in transition, however, please note those signing up in the final two weeks before the race may not be racked with others from their age-group.

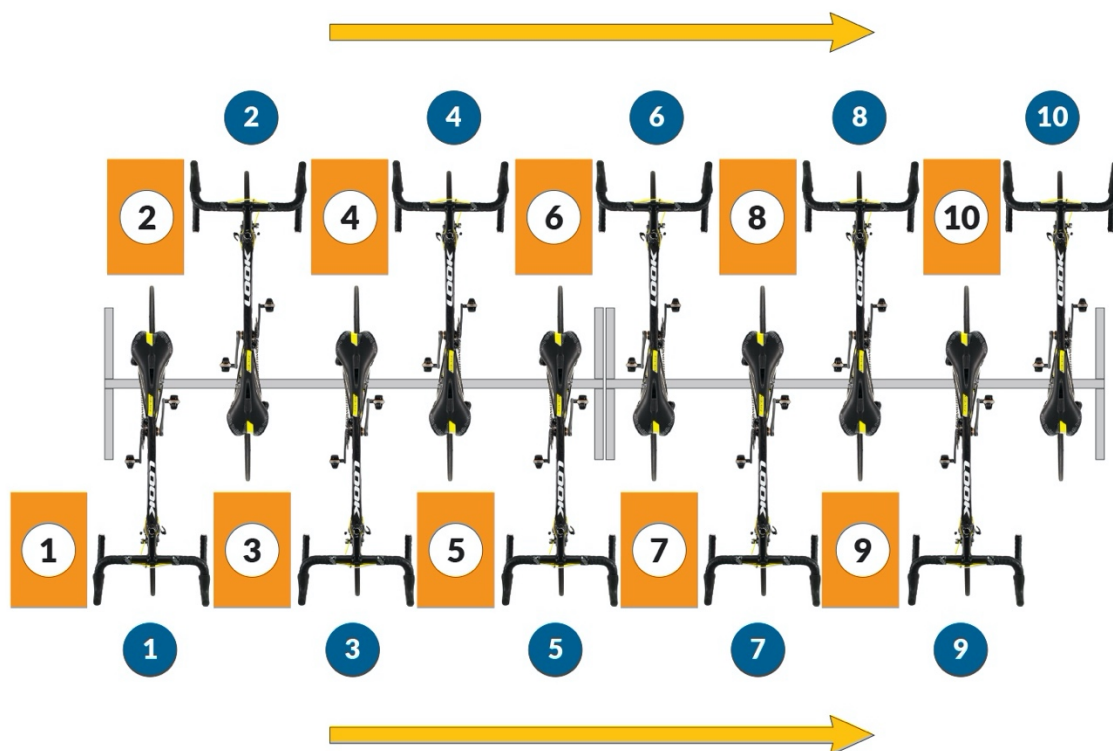

Each numbered space in transition will have one box (measuring 60cm long x 40cm wide x 15cm high). As you follow the flow through transition (away from the beach) your box will be the one immediately **before** your bike position (on the seaward side of your bike). You must place all your kit in the box. We will be operating a clean transition area which means nothing should be left outside your designated box except for your running shoes (which can be placed neatly in front of your box) and anything attached to your bike (nutrition, etc.).

Transition will close for sprint distance athletes at 7:45am and standard distance at 8:30am. This is to ensure transition is clear and safe, ready for the race start.

There will not be a designated baggage area at the event. All your belongings must be placed in your own transition box. Please do not bring more kit than will fit into the box provided.

As soon as you have placed your bike and other belongings in transition, and made use of the toilets, you can move to the start beach. The route across the beach will be carpeted and most of the run from the swim exit to transition is on grass, so you should not wear shoes to the start. Any shoes discarded at the swim start will be disposed of.

Swim warm-up

If you wish to get in the water before the start, please do so on the beach to the west of the swim exit beach. This is the beach with beach huts adjacent to the Wishtower Slope. Please note there is no swim safety cover for the warm-up area and you will swim at your own discretion.

Start Procedure

Your swim cap colour will identify your start wave. Age-groups will be grouped together in the same wave to ensure the age-group competition is fair. Details of which wave you are in will be emailed to you shortly before the event.

As you arrive onto the beach, you must pass through the swim arch. This will give us a count of all athletes starting the race. Please do not bypass the arch. Once you have passed through the swim arch into the start area you will line up along the shore. This year the start will be a mass 'gun start'. Your time will start along with everybody else's when the start siren sounds. If you are nervous about the mass start, we suggest placing yourself slightly further back and/or to the right at the start.

A marshal will be available to take any prescription glasses which will then be placed on a table near the swim exit.

The first sprint distance wave will start at 7:50am. The standard distance will start at 8:50am (male/open age groups) with a second wave at 9:00am (female and remaining male/open).

Wetsuits

We will monitor the water temperature throughout race week. **On race day it is expected to be around 14 degrees Celsius** but can vary between 11 and 16 degrees. **Please note wetsuits are mandatory below 14 degrees.** It is recommended that wetsuits are worn by all novices and age-groupers even if the temperature is above 14 degrees as the wetsuit will not only keep you warm but will also help you swim faster as it provides you with extra buoyancy. Surf and shortie

wetsuits are allowed, but these are totally different to a triathlon specific wetsuit, which is designed for swimming.

The swim hats provided are compulsory. Socks are not permitted unless the water temperature is below 14 degrees. Where socks are permitted the bottom of the wetsuit must cover the top of the sock. Please note the exit of the swim will be carpeted to protect your feet from the stones. **Gloves are not permitted.** We strongly advise you to practice swimming in your wetsuit before the event. Practicing getting out of the wetsuit will help with your transition on the day too (baby oil on the wrists and ankles will help with wetsuit removal in transition).

Wetsuit Hire

If you want to hire a wetsuit from Tri Wetsuit Hire, please book in advance using the following link. Your wetsuit will be waiting at the event on Saturday for collection.
<https://www.triwetsuithire.co.uk/products/tribourne-triathlon-wetsuit-hire>

Swim Safety

For many, the swim is the most daunting part of the race, but don't worry! Our water safety team will be there to guide you and help if required. The team, provided by First Aqua and the Eastbourne Voluntary Lifeguards, consists of fully qualified lifeguards in kayaks, SUP and rescue boats as well as additional lifeguards on the beach. All lifeguards are members of either the BCU Lifeguards or Surf Lifesaving GB. If this is your first triathlon, or swimming is not your strongest discipline, we recommend you position yourself towards the back of the start. **If you do get into difficulty, lie on your back and raise your arm;** a lifeguard will come to you and if necessary, arrange a safety boat to take you to the water's edge. Please do not use backstroke unless you have informed us in advance as this can be easily confused with a swimmer indicating they are in difficulty.



TRI
WETSUIT
HIRE

triwetsuithire.co.uk

TURBO
TRAINER
HIRE

turbotrainerhire.co.uk

BIKE
TRAILER
HIRE

kidsbiketrailers.co.uk

SNOW
CLOTHING
HIRE

snowclothinghire.co.uk

Nationwide Outdoor Kit Hire.
Delivered To Your Door.

Sprint Distance Swim Route

As you leave the beach you will head to the left (towards the pier), swimming around the outside (right) of the first **yellow** buoy (to ensure you clear the end of the first groyne). You will then head towards the pier. After passing the bandstand on your left, make a hard right turn around the first **red** buoy heading back and away from the beach. Make the final right turn back towards the beach towards the finish arch.

Keep the first yellow buoy to your left and the red buoys to your right.



Standard Distance Swim Route

As you leave the beach you will head to the left (towards the pier), swimming around the outside (right) of the first **yellow** buoy (to ensure you clear the end of the first groyne). You will then head towards the pier against the current. The current is weakest close to the beach but beware of colliding with the groynes which extend below the water. After passing the bandstand on your left, **ignore the first red sprint distance turn buoy and continue following the beach all the way to the pier.**

Just before the pier you will make a 90 degree turn to your right and swim parallel to the pier all the way to the end of the pier. The current will pull you to your right (away from the pier), you will need to continuously aim slightly left towards the pier to compensate. If you allow yourself to be pulled too far right, you will have to fight against the current to get back to the next turn.

At the end of the pier, turn right and swim parallel to the beach. This will be a fast section as you swim with the current. There will be a number of yellow sighting buoys along this section to guide you towards the final turn. When you reach the final **red** turn buoy, make the final right turn back towards the beach, the current will be pulling you left. Aim to the right of the finish arch (towards the start beach) and allow the current to pull you left to the finish. If you allow yourself to be pulled too far to the left, you will find yourself battling against the current to get back to the finish.

Keep the first yellow buoy to your left and the red buoys to your right.



OUTGOING TIDE

From 1-2 hours before high tide until 1-2 hours before low tide

SWIMMING AGAINST THE CURRENT

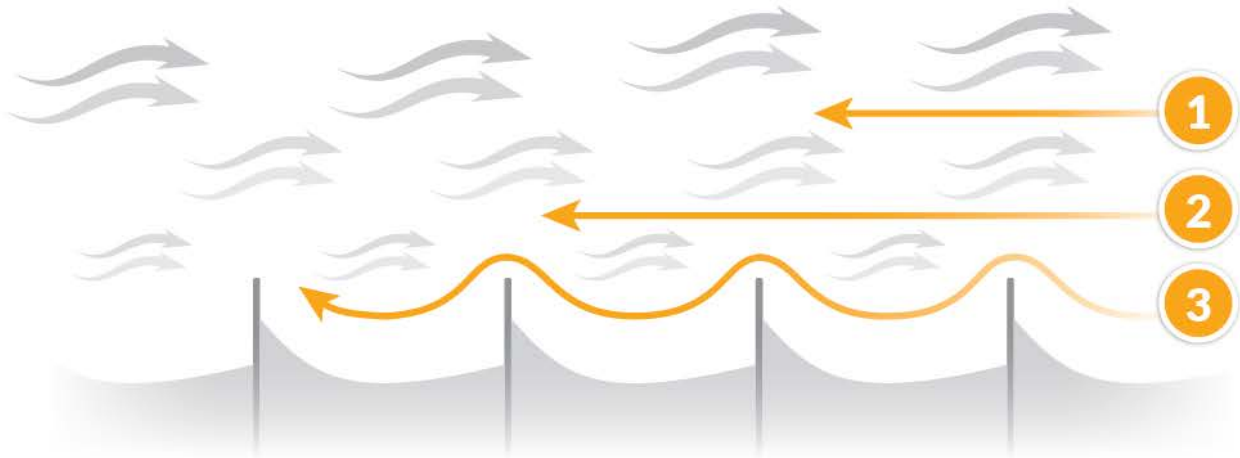

1

Currents get progressively stronger further from the shore. Avoid swimming too far out where the currents are strongest.

2

In most conditions swimming a straight line just beyond the groynes is the fastest option. *

3

When the current is extra strong you could consider sheltering between groynes. *

* Take care as groynes extend out below the surface.

SWIMMING ACROSS THE CURRENT

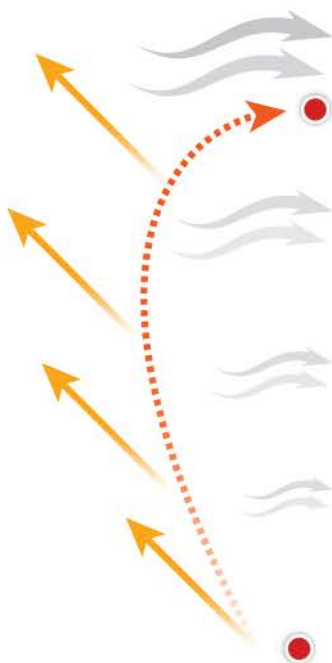

SWIMMING OUT

As you swim out, the current will pull you from left to right. Aim up to 45 degrees to the left of the target (yellow arrows). * Initially you will appear to be swimming too far to the left but as you get further out the current will get stronger and pull you back onto the turn buoy (orange dashed arrow).

SWIMMING BACK

As soon as you turn back towards the shore you should aim up to 45 degrees to the right of the target (yellow arrows). * Initially you will still be pulled a bit too far to the left (orange dashed arrow).

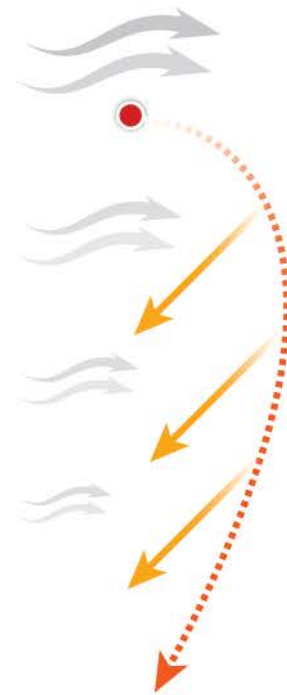

* The angle depends on the strength of the current and how strong you are as a swimmer:
Stronger swimmer and/or weaker current = smaller angle (15 - 30 degrees)
Weaker swimmer and/or stronger current = larger angle (30 - 45 degrees)



TRIBOURNE
MULTISPORT EVENTS
ZONE3

Swim Exit

Volunteers will be on hand to guide you out of the water. Once you have exited the water you will need to make your way on foot to the transition area which is 300m away on the Western Lawns. The beach will be carpeted and most of the run to transition is on grass. You may pull your wetsuit down to your waist as you make your way to transition, however you may not remove your wetsuit completely until you reach your spot in transition.

Swim Cancellation

In the unlikely event the swim is cancelled the swim portion will be replaced with a 2.5k run for sprint athletes and a 5k run for standard distance athletes (following the duathlon routes outlined below).

Duathlon Start/Run 1

The duathlon will start on the lower prom at the corner of the Wishtower car park. Your first run will be a 2.5km out-and-back route along the lower prom towards Holywell. Standard distance competitors will complete two laps. As you finish the run you will then join the swimmers exiting the beach and follow the same swim-to-transition route as the triathlon competitors.



Transition 1: Swim to Bike

You will leave the beach and cross the lower prom onto the Wishtower Slope. You will run uphill over the grass and enter the Western Lawns via the path at the northeast corner of the lawns.

All routes are well marked but please make sure you familiarise yourself with the route from the swim exit to transition and through T1 when switching between disciplines, and especially note where you racked your bike.

You will run into transition to where your bike is racked. You must put your helmet on and ensure it is done up before taking your bike. Only after your helmet is securely in place should you then take your bike and push it out of the transition area to the mount point on the road.

Do not mount your bike until you have crossed the mount line.

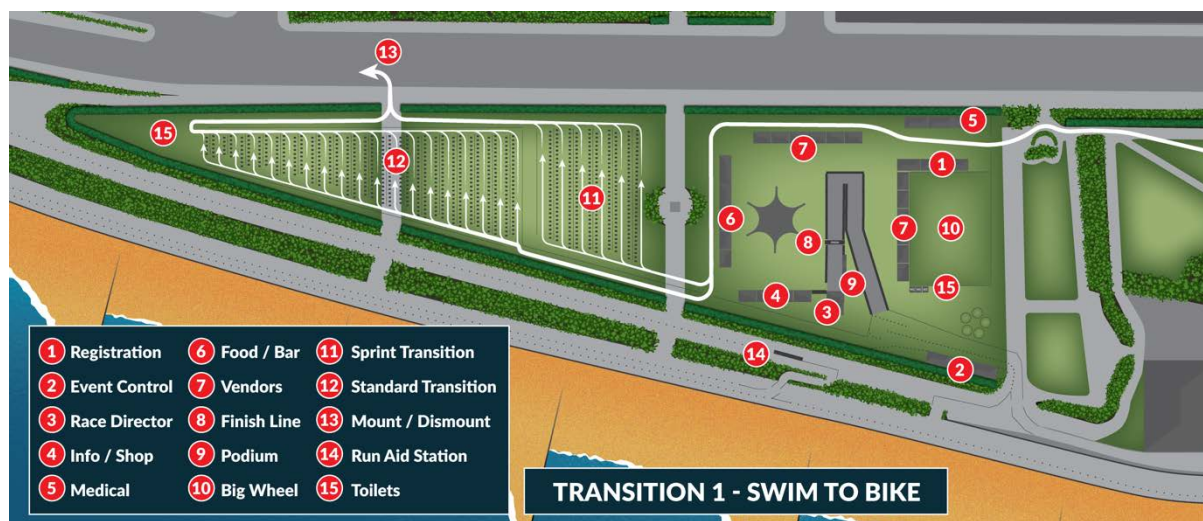

Relay Teams

Relay exchanges will take place at your designated racking position in the transition area. Your timing chip is your 'baton' and must be exchanged between competitors.

Swim to Bike (T1) exchange: The cyclist must wait next to their bike in transition with their **helmet off**. The cyclist should be wearing their race number on their back and can have all cycling clothing on including shoes except for their helmet. The swimmer must first hand over the timing chip which must be attached to the cyclist left ankle. Only when this is complete can the cyclist take their helmet and put it on before taking their bike and pushing it out of the transition area to the mount point on the road.

Bike to Run (T2) exchange: The runner will be waiting at the numbered racking point in transition. The incoming cyclist will dismount, enter transition, rack their bike and then remove their helmet. Only after this can the cyclist remove the timing chip and hand it to the runner to place on their ankle. The runner must wear the race number on their front.

1,500 Swim

For competitors in the swim only event, your race time will stop as you cross the timing mat at the swim exit. After finishing you can make your way to the finish line on the Western Lawns to have a finish line photo taken and to collect your medal.

Aquathlon

For those competing in the aquathlon (swim, run) event: Having completed the swim, go to your place in the first row of transition and remove your wetsuit and put on your running shoes. As you run out of your row in transition you will make a **right turn** (whilst cyclists will be turning left). You will turn right again merging to cross with swimmers entering transition before turning left onto the run route. Please take care when crossing the path of incoming swimmers. Please note, **standard distance aquathlon competitors will be racked in the sprint distance transition area** alongside the sprint distance aquathlon competitors.



EASTBOURNE

INTRO OFFER

£20 FOR 2 WEEKS

unlimited hot yoga

BOOK ONLINE: www.hotpodyoga.com

Two weeks unlimited Yoga for £20 and 20% discount. Use code: TRIBOURNE20

Bike Routes



IMPORTANT:

This is an 'out and back' bike route. This means that competitors will be heading in both directions along the entire route. We do not want to see any head on collisions, so for this reason it is critical that you **do not cross the centre line at any point** during the bike route. This is especially important on the s-bends descent from Beachy Head down towards Birling Gap, and on the 'zig-zigs' as you descend back down towards the finish.

THE PENALTY FOR CROSSING THE CENTRE LINE WILL BE DISQUALIFICATION

NO BLOCKING: Unless overtaking, please keep to the left to allow other competitors to overtake you without them needing to cross the centre line.

Closed Roads

The entire cycle route will be closed to traffic. Please note that whilst the roads are closed to through traffic, we need to maintain escorted access for residents. Whenever a local resident needs to pass through the closed road sections, they will be escorted by a motorcycle official. **Please be aware that you may encounter vehicles within the closed road sections of the course.**

Cycle Route

You will cross the mount line marked on the road and indicated by a marshal before mounting your bike. Mounting before the mount line could result in a time penalty.

You will head west along King Edward's Parade towards Beachy Head. This first section is a steady uphill drag so pace yourself. Just before Bede's School at 1.4km you will reach a zebra crossing which will be closed to pedestrians, however pedestrians will still need to cross the road at various points along the route so please remain vigilant.

Just after the zebra crossing you will follow the road around to the right and begin the climb of Upper Duke's Drive which zig zags upwards for around 1.5km before joining Beachy Head Road.

No overtaking / Neutralised zone

At the top of Upper Duke's Drive, you will enter a short 'no overtaking' section just over 200m long. Competitors heading in both directions will be sharing a single carriageway of the road, separated by a row of cones. Traffic will be using the opposite carriageway. You must keep tight to the left in single file to avoid oncoming cyclists. This section will be neutralised with two timing mats to ensure no competitor is unfairly disadvantaged being held up behind a slower cyclist going up the hill. Within this neutralised zone, drafting rules will not be enforced.

You must not stop or slow down significantly such that you block the route. If you have a mechanical problem within this section, please move off the road as quickly as possible. To prevent competitors spending an unreasonable time in the neutralized zone, a cumulative neutralized time limit will be imposed of 3 minutes for sprint distance and 6 minutes for standard distance. This is the maximum neutralized time that can be subtracted from your overall elapsed time.



On your return, this section will be taken downhill. Please take this section slowly and carefully, remaining aware of cyclists coming towards you. There is nothing to be gained by taking this section fast as your time in this neutralized zone stops.

As you make the left turn at the end of the neutralised zone, you will continue along a gently undulating section to Beachy Head. After passing Beachy Head (pub in the right) you will begin to descend to the 'S-bends'. Please take care and do not cross the centre line. As you take the initial right bend the temptation is to cut the corner. As you exit the left bend, you are at risk of running wide into oncoming cyclists, so take this bend with care.

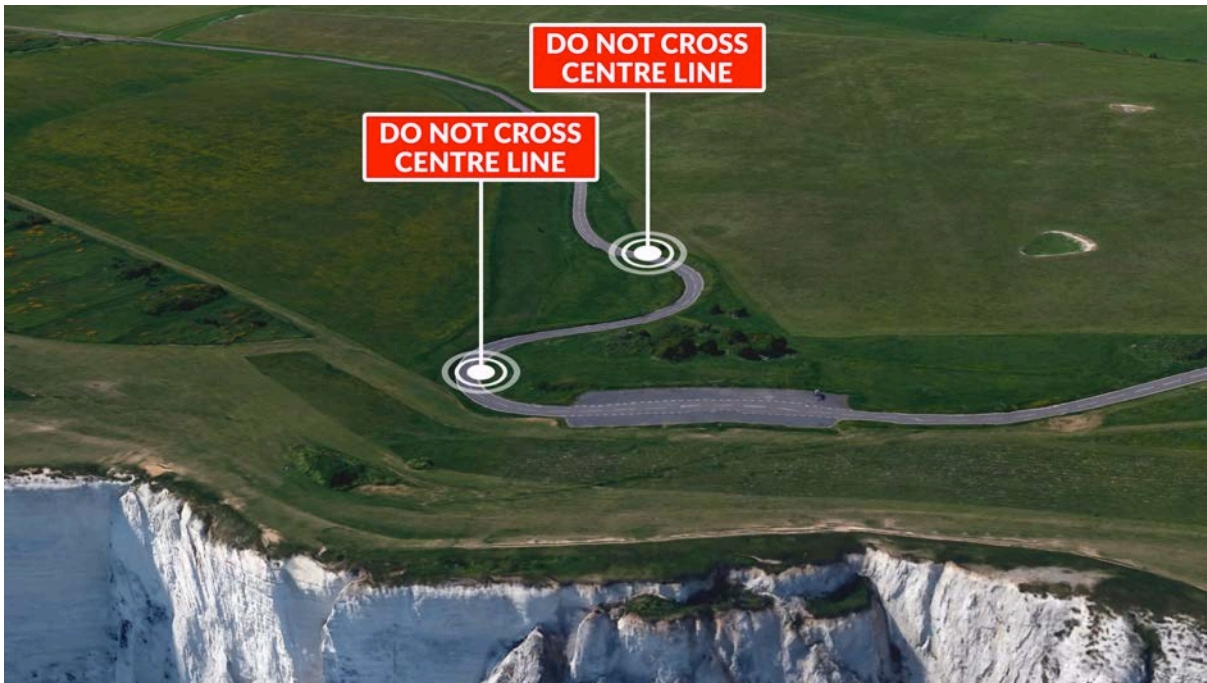

After the S-bends you will have a long fast descent to the turn point at Birling Gap. As you approach the turn, slow right down. This will be a tight U-turn in the road. We will extend the width of the road with carpeted wooden boards to give you a larger turning circle. If you are not confident making this tight turn without putting your foot down, please take the turn wide to allow more confident competitors to pass you on the inside.

You will now return the way you came. The long drag up to Beachy Head starts gently and gradually gets steeper towards the top. The final section around the S-bends is the steepest. Having past Beachy Head, you will soon arrive at the right turn into the neutralised, single-file section as described above.

Please note, road closures and traffic management will end at 11:45am. Any athletes passing this point after 11:45am may need to stop and give way at these junctions, following the highway code.

Once you have passed the neutralised zone you will begin the technical descent into Eastbourne. Take care as you descend Upper Duke's Drive (the 'zig-zags') as it is fast and winding with some tight turns. Remember you could have cyclists coming up the hill towards you so **do not cross the centre line**. Take extra care on the final right bend as cars could be parked on your left on the outside of the bend.

At the bottom of the hill, you will take a final left bend onto King Edward's Parade (the seafront). **The road surface from the final corner through to beyond the zebra crossing is not good so take care.** Potholes here will be marked with white paint.

You will continue past the point opposite the dismount line until just before the next zebra crossing where you will make a U-turn back up to the dismount line.



Standard Distance

The standard distance route is two laps of the route described above. When finishing the end of the first lap, keep to the right of the dismount area to continue onto the second lap. When finishing the second lap, keep left towards the dismount line.

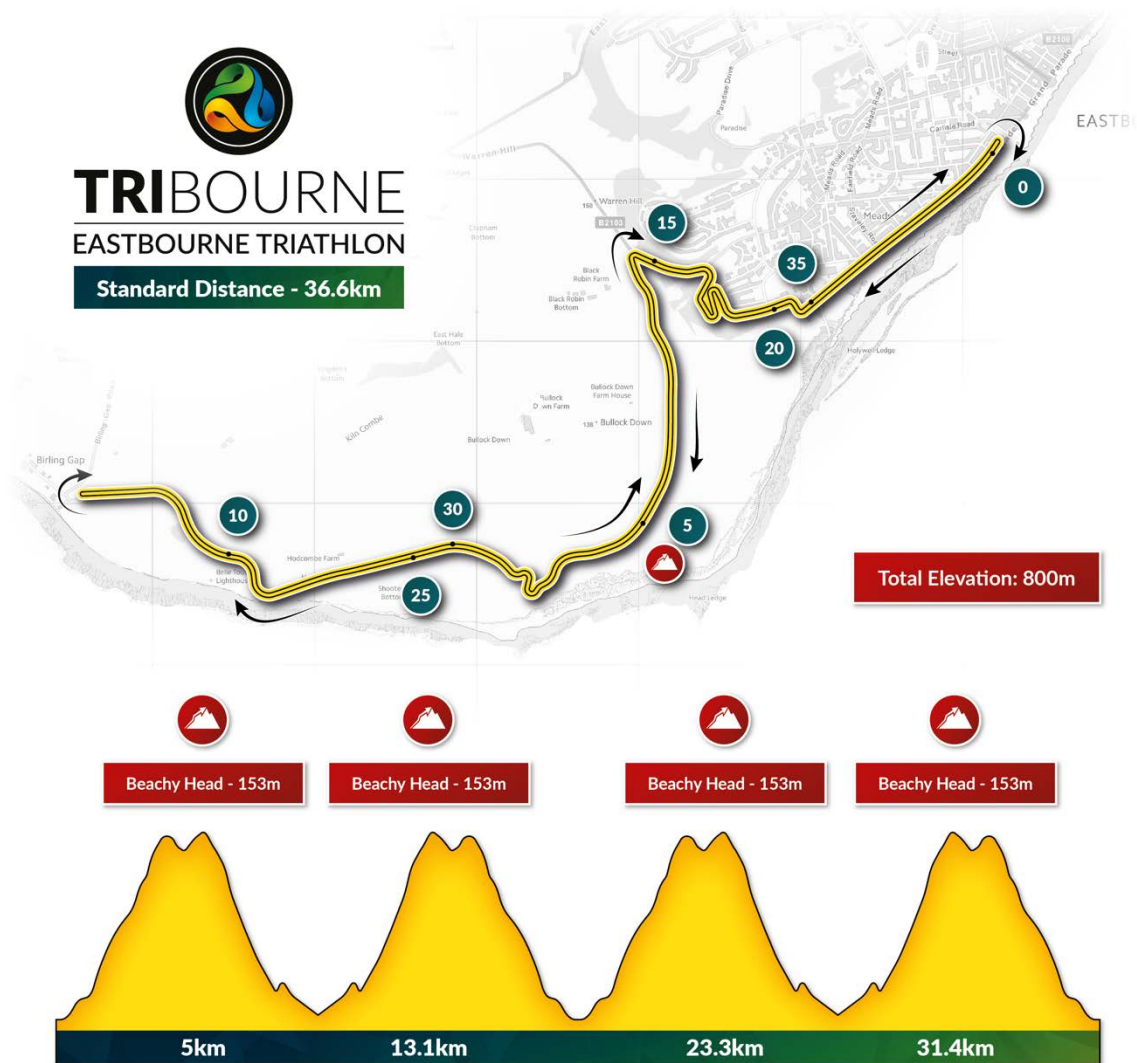

ZONE3

20% OFF

TRIBOURNE20



Drafting

Drafting (taking shelter behind or beside another competitor) during the cycling leg of the race, is not allowed. The cycle draft zone will be 10 metres long measured from the leading edge of the front wheel. You may not enter the draft zone of another competitor except for the purpose of overtaking. When overtaking you must be seen to be progressing through that zone. A maximum of 20 seconds is allowed in order to pass through the draft zone of another competitor. If an overtaking manoeuvre is not completed within 20 seconds the overtaking cyclist must drop back. When a competitor is passed by other competitors, it is his/her responsibility to drop back in order to move out of the draft zone of the overtaking competitor. Failure to do so may result in an official caution or time penalty. A competitor is passed when another competitor's front wheel is ahead of his/her front wheel. Motorcycle and static BTF referees will patrol the course to enforce the no drafting rule.

Competitors must keep to the left side of the course and not create a blocking incident. Blocking is where a competitor who is behind cannot pass due to the leading competitor being poorly placed on the course.

Always cycle on the left-hand side and beware of competitors overtaking you on the right. Please pay attention to the marshals' instructions. It is your responsibility to count your own laps and know the route.

No Littering

We are fortunate to have a beautiful location here for triathlon. Part of the course is within a National Park. **Dropping litter on any point of the course will result in disqualification.**

Race Stop Procedure

In the event of a significant incident on the bike course, the following procedures will followed:

- **YELLOW FLAG** means **CAUTION**. Please slow down.
- **AMBER hazard lights** on motorcycles means **NO OVERTAKING**. Do not pass the motorbike, this will likely be part of a rolling roadblock procedure.
- **RED FLAG** means **STOP**. Stop and wait for further instructions. You may be asked to return to transition or a designated evacuation point depending on the incident.
- **GREEN FLAG** means **GO**. Racing can recommence, this will likely be preceded by a 1-minute verbal warning that racing is about to recommence.

Intentional failure to observe these warnings will result in immediate disqualification.

DRAFTING RULES EXPLAINED

All the below are taken from the British Triathlon Competition Rules, available to download from the British Triathlon website.

WHAT IS DRAFTING?

IT'S AGAINST THE RULES

Taking shelter behind another competitor or motor vehicle during the bike phase to gain a competitive advantage.

THE DRAFTING ZONE

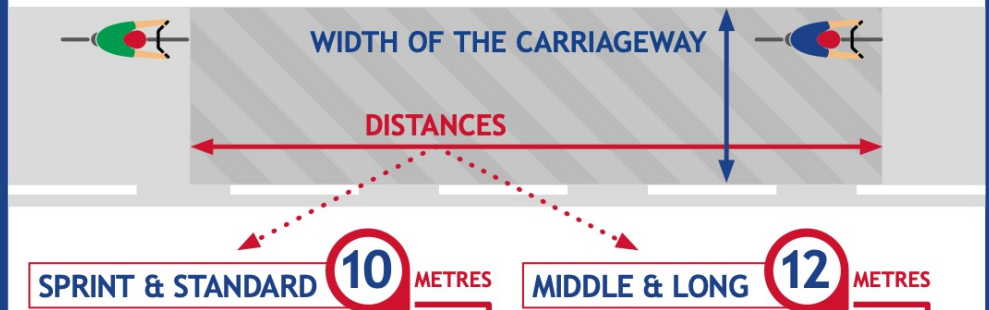

DRAFTING & NOT DRAFTING

✓ NOT DRAFTING

⚠ DRAFTING BIKE

LEAD BIKE

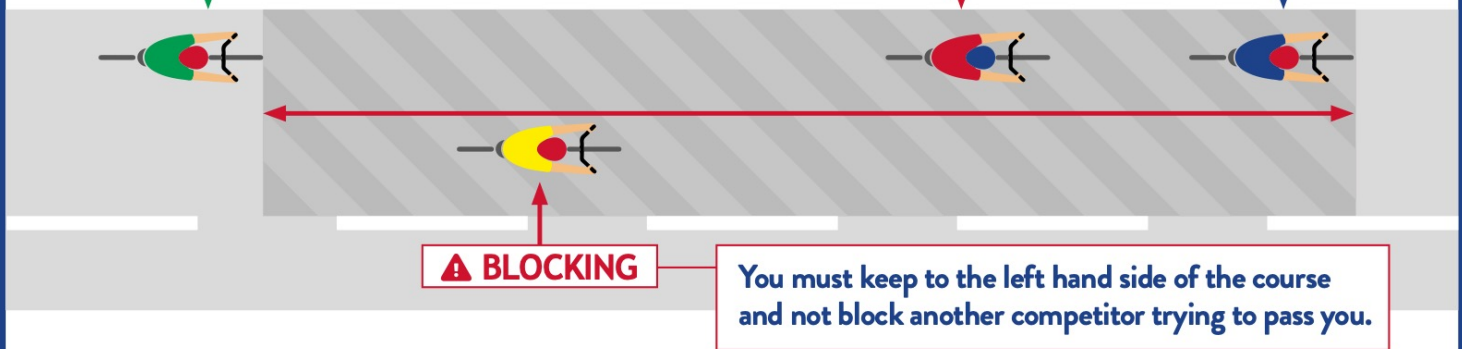

MAKING A PASS

You may enter the draft zone to make a pass within the time allowed.

SPRINT & STANDARD

20
SECONDS

MIDDLE & LONG

25
SECONDS

If the pass cannot be made you must drop back.
Any overtaken cyclist must drop back once passed.



OTHER VEHICLES

You must remain **12 metres** behind motorcycles and **35 metres** behind other vehicles to prevent drafting.

PENALTIES

	1st Offence	2nd Offence	3rd Offence
SPRINT	1 MIN PENALTY	DISQUALIFICATION	N/A
STANDARD	2 MINS PENALTY	DISQUALIFICATION	N/A
MIDDLE / LONG	5 MINS PENALTY	5 MINS PENALTY	DISQUALIFICATION



Motorcycle Officials do not have to provide a warning about drafting for safety reasons.

Transition 2: Bike to Run

Having dismounted your bike before the dismount line, you will run with your bike into transition. Run to your position in the transition area and rack your bike. Only after your bike is racked can you remove your helmet. **Do not unclip your helmet until your bike is racked, doing so will result in a penalty.** Remove your helmet and put on your run shoes. Make sure your helmet and any other kit is placed in your box. You will then run out of the transition area onto the run course via the 'Run Out' exit.

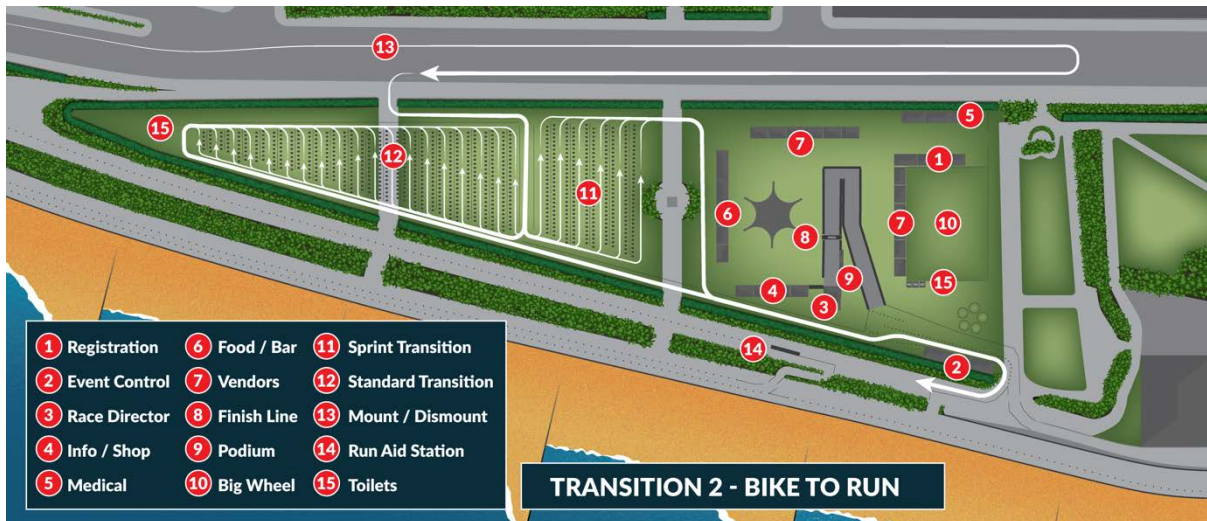

Run

The 5km run lap consists of two out and back sections. The first is along a gravel path and the second is along the lower prom. Always pass to the right of oncoming runners. Keep right and overtake to the left (taking care to avoid oncoming runners). As you run out you will have the public to your right and oncoming runners to your left. On the return you will keep to the right (again with oncoming runners to your left).

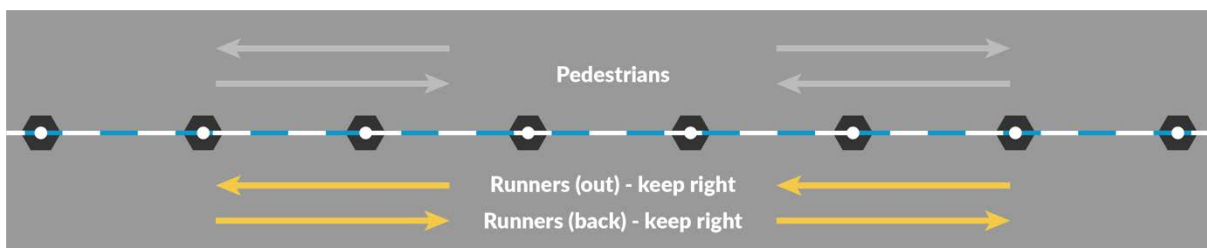

The sprint distance is a single lap of 5km, and the standard distance is two laps. The first 1km is a gradual uphill (barely noticeable) along a gravel path. Mostly the gravel is firm and compact but a few sections it is a little looser and there are few slightly uneven sections. Just past 1km you will make a U-turn and return down the same path. Once you arrive back to the tarmac section alongside transition you will pass the aid station and then make a sharp right turn down a short narrow slope (take

care). You will then run out for a little over 1km along the flat tarmac prom. Just before Holywell Drive you will make a U-turn. Keeping to your right return all the way along the lower prom, past the Western Lawns (transition) as far as the beach where you exited the swim. At this point, you will turn sharp left towards the finish.



As you approach the finish area, sprint competitors will keep right to the finish whereas standard distance competitors will keep left to begin lap 2.

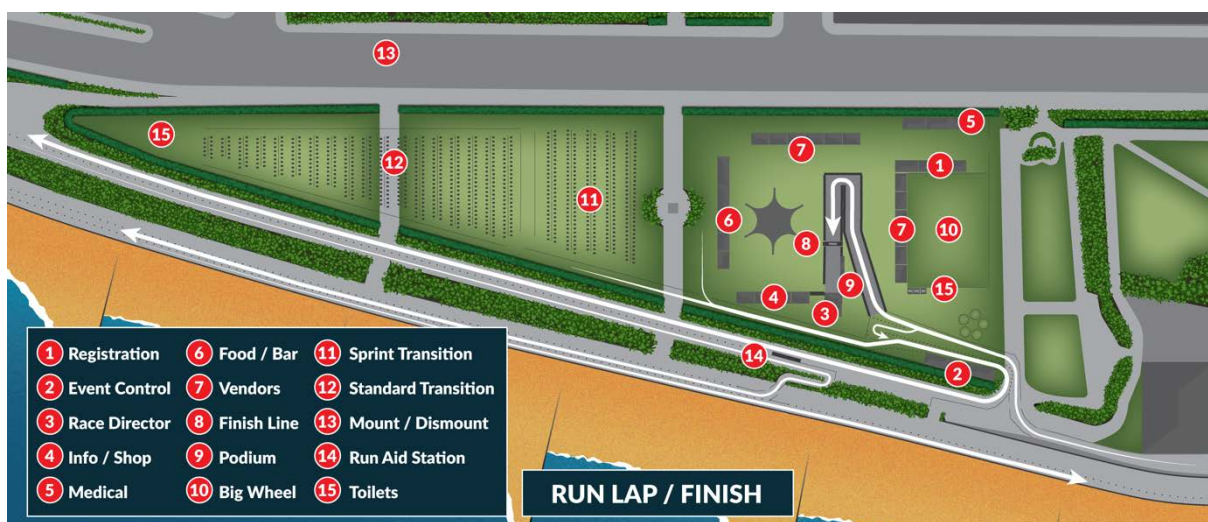



TRIBOURNE EASTBOURNE TRIATHLON

Standard Distance - 10km



Please be aware of pedestrians and other competitors trying to pass you and take care when passing other competitors. It is your responsibility to navigate the course successfully and safely but don't worry it will be very well signposted and marshalled.

Give yourself some extra motivation by raising money for our official charity partner Macmillan and save 50% on your TriBourne entry.

MACMILLAN CANCER SUPPORT

Run Aid Station

On the run route there will be an aid station as you leave transition to start the run. You will pass the aid station again in the opposite direction at 2.3km. Standard competitors will then access this aid station again on the second lap at 5km and 7.3km. The aid station will be stocked with water, HIGH5 Energy Drink and HIGH5 gels.

Finish and Post Race

Once you have crossed the finish line, you will be presented with your medal. You will then collect your finisher t-shirt by showing your race number and handing in your timing chip at the TriBourne Shop. There will be water and HIGH5 Energy Drink available. Once the last cyclist in your race has finished the bike leg, you will be allowed to return to transition to retrieve your bike and other kit and belongings. **We want to create an amazing atmosphere for our last finishers so please stay around the finish area after your race.**

Post-race massage is available from Sportswise on a donation basis.



Food and Drinks

We will once again have a bar and food vendors on site serving alcohol, pizza, fish & chips, ice-cream and more. **Please stay after the race and enjoy a social lunch on the Western Lawns.**

Results and Awards

Please remember, due to the neutralized zone, it is technically possible that someone who started behind you could finish behind you and place above you in the results. As you cross the finish line, your name, time and **current** position will be displayed on the finish gantry. For example, **the finish line may show you as the winner in your age group, but you may yet be beaten by someone behind you!**

All awards are outlined on the following page.

Awards will be presented as soon as possible after the third-place finisher in each category has finished. Where possible, you should check your finishing position via the live results from our website. If you believe you have finished in the top 3 in your age group, please visit the podium area where you will be presented with your award.

With almost 300 awards to present, please note that it may take some time to present your award. If you are an award winner, please listen out for your name to be announced. If you are unable to wait for your awards presentation, you may be able to collect your award early.



Saturday Awards

TriStars:

TriStart - 1st, 2nd and 3rd boy
TriStart - 1st, 2nd and 3rd girl
TriStar 1 - 1st, 2nd and 3rd boy
TriStar 1 - 1st, 2nd and 3rd girl
TriStar 2 - 1st, 2nd and 3rd boy
TriStar 2 - 1st, 2nd and 3rd girl
TriStar 3 - 1st, 2nd and 3rd boy
TriStar 3 - 1st, 2nd and 3rd girl

Super-Sprint Distance:

1st, 2nd and 3rd Male/Open
1st, 2nd and 3rd Female
1st, 2nd and 3rd Male/Open Youth
1st, 2nd and 3rd Female Youth
1st, 2nd and 3rd Male/Open 40+
1st, 2nd and 3rd Female 40+

Mixed Team Relay (2 Males/Open & 2 Females): 1st, 2nd and 3rd Team

Team Relay (any combination of genders):

1st Open Team
1st Female Team

Sunday Awards

Sprint Distance:

1st, 2nd and 3rd Male/Open
1st, 2nd and 3rd Female
Under 20 1st, 2nd and 3rd Male/Open
Under 20 1st, 2nd and 3rd Female
20 to 24 1st, 2nd and 3rd Male/Open
20 to 24 1st, 2nd and 3rd Female
25 to 29 1st, 2nd and 3rd Male/Open
25 to 29 1st, 2nd and 3rd Female
30 to 34 1st, 2nd and 3rd Male/Open
30 to 34 1st, 2nd and 3rd Female
35 to 39 1st, 2nd and 3rd Male/Open
35 to 39 1st, 2nd and 3rd Female
40 to 44 1st, 2nd and 3rd Male/Open
40 to 44 1st, 2nd and 3rd Female
45 to 49 1st, 2nd and 3rd Male/Open
45 to 49 1st, 2nd and 3rd Female
50 to 54 1st, 2nd and 3rd Male/Open
50 to 54 1st, 2nd and 3rd Female
55 to 59 1st, 2nd and 3rd Male/Open
55 to 59 1st, 2nd and 3rd Female
60 to 64 1st, 2nd and 3rd Male/Open
60 to 64 1st, 2nd and 3rd Female
65 to 69 1st, 2nd and 3rd Male/Open
65 to 69 1st, 2nd and 3rd Female
70 to 74 1st, 2nd and 3rd Male/Open
70 to 74 1st, 2nd and 3rd Female
75 to 79 1st, 2nd and 3rd Male/Open
75 to 79 1st, 2nd and 3rd Female
Over 80 1st, 2nd and 3rd Male/Open
Over 80 1st, 2nd and 3rd Female

Sprint Distance Aquathon:

1st, 2nd and 3rd Male/Open
1st, 2nd and 3rd Female

Sprint Distance Duathlon:

1st, 2nd and 3rd Male/Open
1st, 2nd and 3rd Female

Sprint Relay Team:

1st Relay Team Sprint

1500m Swim:

1st, 2nd and 3rd Male/Open
1st, 2nd and 3rd Female

Standard Distance Aquathon:

1st 2nd and 3rd Male/Open
1st 2nd and 3rd Female

Standard Distance Duathlon:

1st, 2nd and 3rd Male/Open
1st, 2nd and 3rd Female

Standard Distance Relay Team:

1st Relay Team

Standard Distance:

1st, 2nd and 3rd Male/Open
1st, 2nd and 3rd Female
Under 20 1st, 2nd and 3rd Male/Open
Under 20 1st, 2nd and 3rd Female
20 to 24 1st, 2nd and 3rd Male/Open
20 to 24 1st, 2nd and 3rd Female
25 to 29 1st, 2nd and 3rd Male/Open
25 to 29 1st, 2nd and 3rd Female
30 to 34 1st, 2nd and 3rd Male/Open
30 to 34 1st, 2nd and 3rd Female
35 to 39 1st, 2nd and 3rd Male/Open
35 to 39 1st, 2nd and 3rd Female
40 to 44 1st, 2nd and 3rd Male/Open
40 to 44 1st, 2nd and 3rd Female
45 to 49 1st, 2nd and 3rd Male/Open
45 to 49 1st, 2nd and 3rd Female
50 to 54 1st, 2nd and 3rd Male/Open
50 to 54 1st, 2nd and 3rd Female
55 to 59 1st, 2nd and 3rd Male/Open
55 to 59 1st, 2nd and 3rd Female
60 to 64 1st, 2nd and 3rd Male/Open
60 to 64 1st, 2nd and 3rd Female
65 to 69 1st, 2nd and 3rd Male/Open
65 to 69 1st, 2nd and 3rd Female
70 to 74 1st, 2nd and 3rd Male/Open
70 to 74 1st, 2nd and 3rd Female
75 to 79 1st, 2nd and 3rd Male/Open
75 to 79 1st, 2nd and 3rd Female
Over 80 1st, 2nd and 3rd Male/Open
Over 80 1st, 2nd and 3rd Female

Key Rules

The race is governed by BTF rules and regulations and BTF Technical Officials will be in attendance on race day so please ensure you read and are familiar with them. You can find them on the British Triathlon website: www.britishtriathlon.org

Some key rules to note are:

- Your race numbers must be correctly fixed to your bike, helmet, and clothing or race belt.
- Your handlebars must not have open ends so please obtain bar-end stoppers to plug them before coming to the bike check-in.
- Appropriate racing attire must be worn for the duration of the race.
- No cycling is allowed in the transition area at any time.
- There will be clearly marked mount and dismount lines at 'Bike Mount and 'Bike Dismount'.
- You must secure your helmet strap before removing your bike from the rack and it must not be undone until your bike is replaced on the rack after finishing the cycle section. You will be penalised should you not comply with this rule.
- Athletes must not use any devices which could cause a distraction such as headphones, mobile phones, cameras, etc. in any distracting manner during the race. Mobile phones can be brought into transition but may not be used whilst the transition area is live.
- Nudity is not permitted, including within the transition area. If you want to change, please bring a changing robe.
- There will be BTF Technical Officials in transition to monitor all competitors.
- A bike helmet is compulsory and must be worn during bike check-in.
- Fixed wheel bikes (bikes that use the pedals as a brake) are not permitted in the race. e-bikes are also not permitted.
- Littering during the event is both against the law and unacceptable. **Anyone seen littering during the event will be disqualified.**
- No outside assistance is allowed.
- Cycles and equipment must be placed in the same position at the start and finish of the cycle leg.

Penalties

Any penalties and DQ's will be posted on a notice board located adjacent to the race control tent near the finish line. **Any live results published during the event are provisional only.**

KNOW THE RULES

All the below are taken from the British Triathlon Competition Rules, available to download from the British Triathlon website.

RULE 2.1 Littering



All litter must be placed in bins or elsewhere specified by the Event Organiser – keep hold of it until you can dispose properly.

RULE 2.1 Racing Conduct

Everyone involved in your race is there to ensure you have a safe and enjoyable experience, so we ask that you respect your fellow competitors and treat all Technical Officials, Event Organisers, volunteers and spectators with courtesy. Any abuse towards these people will not be tolerated.

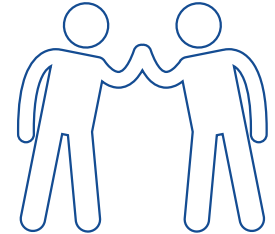

RULE 2.1 Know the Course

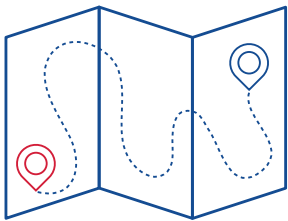

Make sure you know which route to take – check out course maps and if it's unclear, ask the Event Organiser before race day. Marshals are there to ensure the safety of the event, not just to point you in the right direction!

RULE 2.9 Race Numbers

During the cycle stage, race numbers must be visible from the back; during the run stage, race numbers must be visible from the front. Race numbers do not need to be worn during the swim segment. Take care not to fold or damage your number!



RULES 4.10 | 5.2 | 6.4 Illegal Equipment

Certain items are banned during the race – this includes MP3 players, mobile phones and personal video recording devices. Leave these outside transition.



RULE 5.2 Helmets

Helmets must be clipped before the bike is touched, and remain done up until the bike is racked after the cycle stage.

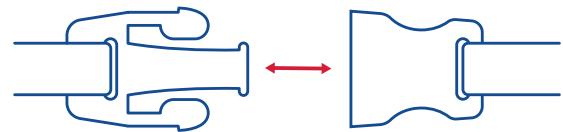

RULE 5.5 Drafting

Competitors must keep their distance from the cyclist in front of them, so as not to gain an advantage.



In standard distance and shorter events, the gap between the front wheel of the leading bike, to the front wheel of the following bike should be 10 metres – if overtaking a competitor, you have 20 seconds to pass through their draft zone.

In middle and long distance events, the gap is 12 metres and the time allowed to pass through is 25 seconds.

RULE 7.1 Transition

Competitors should only bring into transition what is needed – a small bag can remain but large, bulky boxes are to be taken out of transition whilst the race is live.

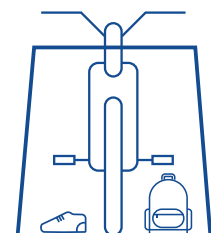

Medical Considerations

Our event medical team, East Sussex Medical Event Services will be on standby for any first aid or medical treatment. Their main treatment facility will be located near the finish line and medical teams will be stationed or mobile at various places on the course.

Medical Advice - You should discuss any medical problems with your GP before competing in the triathlon. This advice is in addition to anything he or she says. If you have a medical condition put a cross on the front of your race number.

Cardiac Assessment and Screening - If you have a family history of heart disease or sudden death or you have any symptoms of possible heart disease, i.e. chest pain during exercise, sudden shortness of breath, or rapid palpitations, you should see your GP who can arrange for you to have a proper cardiac assessment.

On the Day - Do not compete if you feel unwell or have recently been unwell. This advice applies even if you are raising money for charity. If you feel feverish, have had diarrhoea or been vomiting or had any chest pains DO NOT RACE! Many medical emergencies occur because people who have been unwell but do not want to miss the event

Hydration - Drinking a sensible fluid intake is necessary for a triathlon. Your thirst is the best and safest guide to how much to drink during the event. You should start the race adequately hydrated and then drink small amounts as your thirst dictates. Avoid drinking too much fluid before, during or after the race, as it is possible to get ill from drinking too much fluid (this applies to water or sports drinks).

FAQs

Are there changing facilities & showers?

There are no changing facilities. We recommend you arrive ready to race and bring some warm clothes for afterwards. There are a limited number of public showers on the beach.

What do we do with lost property?

Please hand any items found to the help desk. We will hold onto any lost property for one month after the race. If you have lost an item of your property, please email us at office@tribourne.co.uk

Can I buy photographs?

Finish line photographs will be available to purchase directly from our official photographers. A link will be emailed to all participants after the race.

Are there any age restrictions to the event?

You must be 15 on or before 31st December 2022 for the sprint distance and 17 on or before 31st December 2022 for the standard distance.

I have a disability; can I still participate?

We are an inclusive event and do our utmost to accommodate participants with disabilities. Please contact us at office@tribourne.co.uk with a description of your disability. We will assess this and establish if it is possible to compete and what we require to make this feasible.

What is the British Triathlon Federation (BTF) day membership for?

The BTF day license is a license for racing and covers your public liability insurance for the day. For further information on race licenses please contact the BTF directly www.britishtriathlon.org.

I am unable to race; can I have a refund or transfer my place to next year?

Unfortunately, due to our very tight budget and the impact that deferrals would have on our financial position next year, we can't offer a refund or deferral within the last 4 weeks before the race.

Can I use tribars on my bike?

Yes, tribars are allowed. Tribars and handlebar ends must be plugged, and they must be secure. Unlike draft legal races, there is no requirement for them to be shorter than the brake levers.

Is the race draft legal?

No. Drafting is against the rules. See the drafting section earlier in this document.

How can I find out my finish time?

Results will be posted on our website following the race at www.eastbournetriathlon.co.uk

I still have my timing chip; how do I return it?

Please post your timing chip back to us at: TriBourne Multisport Events Ltd., 37 Hill Road, Eastbourne, BN20 8SN. If we do not receive this, you will be liable for the £40 cost of the chip.

Do you need volunteers?

We need lots of volunteers to help make this a great event. If any of your friends or family are interested in being part of this major sporting event, please ask them to email volunteers@tribourne.co.uk. Each volunteers will receive a hot meal, hot drinks, water bottle, t-shirt and £25 credit for each 4 hour shift.

Are there any toilets?

Yes, there will be toilets within transition on the Western Lawns.

Are drinks provided?

Yes, there will be an aid station on the run and at the finish line.

What are the rules?

The race is governed by BTF rules and regulations and BTF Technical Officials will be in attendance on race day so please ensure you read and ensure you are familiar with them. You can find them on the British Triathlon website: www.britishtriathlon.org

Who are we?

We are Mat Dowle and Dale Anderton, both experienced triathletes living in Eastbourne. We have set up TriBourne Multisport Event Ltd to facilitate the delivery of the Multisport events in Eastbourne which now includes the Eastbourne Triathlon, IronBourne and Brighton & Hove Triathlon. Between us we have many hundreds of hours of racing experience at all levels and over all distances. We have experienced everything that is both good and bad about racing triathlon, and this experience puts us in a great position to deliver the best possible, athlete focussed race experience.

Mat Dowle came to triathlon relatively late in life, completing his first triathlon in 2006 at the age of 29. Since then, he has completed over 20 Ironman distance races and countless shorter distance events.

“I started running in my 20’s and completed many marathons and ultra-distance running events. After 10 years of running, I needed a new challenge and entered my first triathlon (Ironman France). At that time, I had never learned to swim, so the build up to that first Ironman was a steep learning curve. I conquered the swim, mountains, and the heat of the run, ending up with a decent result... I loved the experience and there was no going back!”

“Over the past 20 years I’ve completed many triathlons over all distances from sprint to Ironman. I’ve picked up some good results over the years and I’ve been on the GB Age Group Team at several World and European Championship events.

“I’m a perfectionist and I hope my commitment and attention to detail will result in an outstanding race experience for everyone involved.”

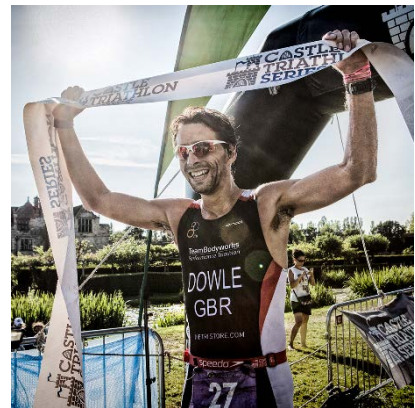

Dale Anderton has been involved in triathlon and endurance sports for over 40 years.

“I fell in love with triathlon and the endurance way of life in the 1980’s whilst serving as a Royal Marine and doing my first sprint distance event. Since then, I have competed in 100’s of races across the globe at all distances including the Ironman World Championships in Kona, Hawaii; an experience I will never forget.

“I moved to Eastbourne to study a Sports Science Degree in 1994 and now I wouldn’t want to live anywhere else. I train with many great local clubs such as Meads Runners, Team Bodyworks and Run Wednesdays and see this event as a way of giving

something back to the community and sport that has given me so much over the years.

“Our aim is to provide everyone the best experience possible, whether you’re an international professional athlete or if this is your first multisport event.”

EASTBOURNE TRIATHLON FESTIVAL

Is approved by: TRIATHLON ENGLAND

Permit approved on: 24/05/2023

Based at: WESTERN LAWNS, EASTBOURNE

Event date: 10/06/2023 -
11/06/2023

Organised by: TRIBOURNE EVENTS LIMITED

THIS EVENT PERMIT ENSURES:

The event will be conducted in accordance with the British Triathlon and International Triathlon Union rules, as outlined in the current British Triathlon Competition Rules.

The event will be conducted in a fair and safe manner.

The events planning and preparation meets the standard of quality required by British Triathlon and the Home Nations.



Jonny Hamp

Director of Events - British Triathlon

This event has received a British Triathlon Event Permit approved by the Home Nation Associations.

The event has the appropriate volunteer and participant insurance.

The Event Organiser has completed a thorough review of the swim, bike and run courses (as applicable) and has evaluated and considered all medical, safety and emergency requirements for the event.

The Event Organiser maintains a positive image of the sport of triathlon by setting minimum standards for staging of safe events which are accessible to the public.

Our Sponsors and Partners

The Eastbourne Triathlon would not be possible without the generous support of our headline sponsor Eastbourne College and many other partners.

TRI
WETSUIT
HIRE



Vitx | cycle

KITBRIK

ZONE3 



°CRYOBRIGHT

Sportswise
excellence in Sports Medicine



**MEADS
RUNNERS**

CYCLESHACK



TeamBodyworks
Performance Triathlon

runnersneed
the running specialists

hotpod yoga

T:EMPO

**MACMILLAN
CANCER SUPPORT**



Choice
VEHICLE RENTALS



TRAIN | RECOVER |



°CRYOBRIGHT

#RECOVER
#LIKEAPRO

£15
VOUCHER

YOUR DESTINATION FOR:

- **OPTIMISED HEALTH**
- **ENHANCED WELLNESS**
- **ADVANCED RECOVERY**

EXPERIENCE CUTTING-EDGE WELLNESS & RECOVERY TECHNOLOGY + EXPERTLY DELIVERED HANDS ON THERAPIES TO HELP YOU FEEL BRIGHTER INSIDE & OUT



SCAN WITH PHONE CAMERA
TO CLAIM YOUR £15 VOUCHER

T&Cs APPLY

🌐 [Cryobright.co.uk](https://cryobright.co.uk) 📞 01273 777474 📷 @cryobright

**FOR APPTS
CALL OR
BOOK ONLINE**

TRAIN. RECOVER. REPEAT.



OUR SERVICES CAN HELP:

- DECREASE SWELLING & INFLAMMATION | BOOST ENERGY
- DIAGNOSE & TREAT INJURY | REDUCE PAIN & MUSCLE SORENESS
- MAINTAIN JOINT HEALTH | IMPROVE MOBILITY & FLEXIBILITY
- REDUCE RISK OF INJURY | PROMOTE SLEEP | RELIEVE STRESS
- SPEED RECOVERY FROM TRAINING OR COMPETITION

01273 777474

HELLO@CRYOBRIGHT.CO.UK

197-199 CHURCH ROAD, HOVE, BN3 2AB